

# TOSHIBA

Leading Innovation >>>

**AIR CONDITIONER (MULTI TYPE)**

## Owner's Manual



### Air to Air Heat Exchanger with DX Coil Unit

Model name: \_\_\_\_\_

Model with a humidifier

**MMD-VNK502HEXE**  
**MMD-VNK802HEXE**  
**MMD-VNK1002HEXE**

Model without a humidifier

**MMD-VN502HEXE**  
**MMD-VN802HEXE**  
**MMD-VN1002HEXE**

For commercial use

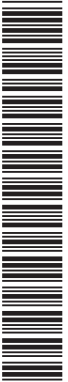

**Original instruction**

Thank you very much for purchasing TOSHIBA Air to Air Heat Exchanger with DX (direct expansion) Coil (& Humidifier).  
 Please read this owner's manual carefully before using your Air to Air Heat Exchanger with DX Coil Unit.  
 • Obtain the "Owner's manual" and "Installation manual" from constructor (or dealer).  
 Request to constructor or dealer  
 • Please clearly explain the contents of the Owner's manual and hand over it.

**ADOPTION OF NEW REFRIGERANT**

This Air to Air Heat Exchanger with DX Coil Unit adopts a new refrigerant HFC (R410A) instead of the conventional refrigerant R22 in order to prevent destruction of the ozone layer.

This appliance is not intended for use by person (including children) with reduced physical, sensory or mental capabilities, or lack of experience and knowledge, unless they have been given supervision or instruction concerning use of the appliance by a person responsible for their safety.

**Contents**

**1 Precautions for Safety . . . . . 2**

**2 Part Names . . . . . 4**

**3 System Configuration . . . . . 5**

**4 Part Names and Functions of the Remote Controller . . . . . 6**

**5 How to Use . . . . . 8**

**6 Timer Operation . . . . . 10**

**7 Installation . . . . . 10**

**8 Air Conditioner Operations and Performance . . . . . 11**

**9 Maintenance . . . . . 11**

**10 When the Following Symptoms are Found . . . . . 12**

**11 Specifications . . . . . 13**

Please read carefully through these instructions that contain important information which complies with the "Machinery" Directive (Directive 2006/42/EC), and ensure that you understand them.

**Generic Denomination: Air conditioner (Air to Air Heat Exchanger with DX Coil Unit)**





**Definition of Qualified Installer or Qualified Service Person**

The Air to Air Heat Exchanger with DX Coil Unit must be installed, maintained, repaired and removed by a qualified installer or qualified service person. When any of these jobs is to be done, ask a qualified installer or qualified service person to do them for you.

A qualified installer or qualified service person is an agent who has the qualifications and knowledge described in the table below.

Agent	Qualifications and knowledge which the agent must have
<ul style="list-style-type: none"> <li>Qualified installer</li> </ul>	<ul style="list-style-type: none"> <li>The qualified installer is a person who installs, maintains, relocates and removes the Air to Air Heat Exchanger with DX Coil Unit made by Toshiba Carrier Corporation. He or she has been trained to install, maintain, relocate and remove the Air to Air Heat Exchanger with DX Coil Unit made by Toshiba Carrier Corporation or, alternatively, he or she has been instructed in such operations by an individual or individuals who have been trained and is thus thoroughly acquainted with the knowledge related to these operations.</li> <li>The qualified installer who is allowed to do the electrical work involved in installation, relocation and removal has the qualifications pertaining to this electrical work as stipulated by the local laws and regulations, and he or she is a person who has been trained in matters relating to electrical work on the Air to Air Heat Exchanger with DX Coil Unit made by Toshiba Carrier Corporation or, alternatively, he or she has been instructed in such matters by an individual or individuals who have been trained and is thus thoroughly acquainted with the knowledge related to this work.</li> <li>The qualified installer who is allowed to do the refrigerant handling and piping work involved in installation, relocation and removal has the qualifications pertaining to this refrigerant handling and piping work as stipulated by the local laws and regulations, and he or she is a person who has been trained in matters relating to refrigerant handling and piping work on the Air to Air Heat Exchanger with DX Coil Unit made by Toshiba Carrier Corporation or, alternatively, he or she has been instructed in such matters by an individual or individuals who have been trained and is thus thoroughly acquainted with the knowledge related to this work.</li> <li>The qualified installer who is allowed to work at heights has been trained in matters relating to working at heights with the Air to Air Heat Exchanger with DX Coil Unit made by Toshiba Carrier Corporation or, alternatively, he or she has been instructed in such matters by an individual or individuals who have been trained and is thus thoroughly acquainted with the knowledge related to this work.</li> </ul>
<ul style="list-style-type: none"> <li>Qualified service person</li> </ul>	<ul style="list-style-type: none"> <li>The qualified service person is a person who installs, repairs, maintains, relocates and removes the Air to Air Heat Exchanger with DX Coil Unit made by Toshiba Carrier Corporation. He or she has been trained to install, repair, maintain, relocate and remove the Air to Air Heat Exchanger with DX Coil Unit made by Toshiba Carrier Corporation or, alternatively, he or she has been instructed in such operations by an individual or individuals who have been trained and is thus thoroughly acquainted with the knowledge related to these operations.</li> <li>The qualified service person who is allowed to do the electrical work involved in installation, repair, relocation and removal has the qualifications pertaining to this electrical work as stipulated by the local laws and regulations, and he or she is a person who has been trained in matters relating to electrical work on the Air to Air Heat Exchanger with DX Coil Unit made by Toshiba Carrier Corporation or, alternatively, he or she has been instructed in such matters by an individual or individuals who have been trained and is thus thoroughly acquainted with the knowledge related to this work.</li> <li>The qualified service person who is allowed to do the refrigerant handling and piping work involved in installation, repair, relocation and removal has the qualifications pertaining to this refrigerant handling and piping work as stipulated by the local laws and regulations, and he or she is a person who has been trained in matters relating to refrigerant handling and piping work on the Air to Air Heat Exchanger with DX Coil Unit made by Toshiba Carrier Corporation or, alternatively, he or she has been instructed in such matters by an individual or individuals who have been trained and is thus thoroughly acquainted with the knowledge related to this work.</li> <li>The qualified service person who is allowed to work at heights has been trained in matters relating to working at heights with the Air to Air Heat Exchanger with DX Coil Unit made by Toshiba Carrier Corporation or, alternatively, he or she has been instructed in such matters by an individual or individuals who have been trained and is thus thoroughly acquainted with the knowledge related to this work.</li> </ul>

## ■ Warning Indications on the Air to Air Heat Exchanger with DX Coil Unit

Warning indication		Description
	<p><b>WARNING</b></p> <p><b>ELECTRICAL SHOCK HAZARD</b> Disconnect all remote electric power supplies before servicing.</p>	<p><b>WARNING</b></p> <p><b>ELECTRICAL SHOCK HAZARD</b> Disconnect all remote electric power supplies before servicing.</p>
	<p><b>WARNING</b></p> <p>Moving parts. Do not operate unit with inspection cover removed. Stop the unit before the servicing.</p>	<p><b>WARNING</b></p> <p>Moving parts. Do not operate unit with inspection cover removed. Stop the unit before the servicing.</p>
	<p><b>CAUTION</b></p> <p>High temperature parts. You might get burned when removing this cover.</p>	<p><b>CAUTION</b></p> <p>High temperature parts. You might get burned when removing this cover.</p>
	<p><b>CAUTION</b></p> <p>Do not touch the aluminum fins of the unit. Doing so may result in injury.</p>	<p><b>CAUTION</b></p> <p>Do not touch the aluminum fins of the unit. Doing so may result in injury.</p>

# 1 Precautions for Safety

## WARNING

### General

- Carefully read Owner's Manual before starting the Air to Air Heat Exchanger with DX Coil Unit. There are many important things to keep in mind for daily operation.
- Ask for installation to be performed by the dealer or a professional. Only a qualified installer (\*1) is able to install an Air to Air Heat Exchanger with DX Coil Unit. If a non-qualified person installs an Air to Air Heat Exchanger with DX Coil Unit, it may result in problems such as fire, electric shock, injury, water leakage, noise and vibration.
- Do not expose your body to cool air directly for a long time and do not cool yourself excessively. Doing so may result in deteriorated physical condition and ill health.
- Consult the shop where you purchased Air to Air Heat Exchanger with DX Coil Unit if Air to Air Heat Exchanger with DX Coil Unit (cooling and heating) is not performed properly as a refrigerant leakage may be the cause. Confirm the repair details with a qualified service person(\*1) when the repair includes additional charging of the refrigerant.
  - The refrigerant used for Toshiba air conditioner is safe.
  - Usually, the refrigerant does not leak. If it should leak and catch fire on a fan heater, stove, or gas range, a toxic gas will be produced.
- Install a circuit breaker that meets the specifications in the installation manual and the stipulations in the local regulations and laws.
- Do not wash the Air to Air Heat Exchanger with DX Coil Unit. Doing so may result in electric shock.
- When the Air to Air Heat Exchanger with DX Coil Unit is operated with a combustion appliance in the same place, be careful of ventilation to let fresh air enter the room. Poor ventilation causes oxygen shortage.
- Be sure to stop running the air conditioner and turn off the breaker before cleaning. Otherwise, injury may result as the fan is rotating at high speed inside the unit.
- Wear protective gloves and safety work clothing during installation, servicing and removal.
- Use of a stand more than 50 cm high to clean the filter of the Air to Air Heat Exchanger with DX Coil Unit or to carry out other such jobs constitutes working at heights. Due to the danger of falling off the stand and injuring yourself while working at heights, this kind of work should not be done by unqualified individuals. When this kind of work must be carried out, do not do it yourself but ask a qualified installer (\*1) or a qualified service person (\*1) to do it for you.
- Do not place any combustion appliance in a place where it is directly exposed to the wind of Air to Air Heat Exchanger with DX Coil Unit, otherwise it may cause imperfect combustion.

### Transportation and storage

- Transport it by the truck or the forklift. Transport it by six people or more when the person transports it temporarily. The waist etc. might be hurt when not following it.
- When transporting the Air to Air Heat Exchanger with DX Coil Unit, wear shoes with protective toe caps, protective gloves, and other protective clothing.
- When transporting the Air to Air Heat Exchanger with DX Coil Unit, do not take hold of the bands around the packing carton. You may injure yourself if the bands should break.
- When stacking the packing cartons for storage or transportation, read the precautions written on the packing cartons. Failure to heed the precautions may cause the stack to collapse.
- You shall ensure that the Air to Air Heat Exchanger with DX Coil Unit is transported in stable condition. If you find any part of the product broken, contact your dealer.

### Installation

- Only a qualified installer(\*1) or qualified service person(\*1) is allowed to carry out the electrical work of the Air to Air Heat Exchanger with DX Coil Unit. Under no circumstances must this work be done by an unqualified individual since failure to carry out the work properly may result in electric shocks and/or electrical leaks.
- After the installation work has been completed, have the installer explain about the circuit breaker positions. In the event that trouble has occurred in the Air to Air Heat Exchanger with DX Coil Unit, set the circuit breaker to the OFF position, and contact a service person. (\*1)
- If you install the unit in a small room, take appropriate measures to prevent the refrigerant from exceeding the limit concentration even if it leaks. Consult the dealer from whom you purchased the air conditioner when you implement the measures. Accumulation of highly concentrated refrigerant may cause an oxygen deficiency accident.
- Do not install the Air to Air Heat Exchanger with DX Coil Unit in a location that may be subject to a risk of expire to a combustible gas. If a combustible gas leaks and becomes concentrated around the unit, a fire may occur.
- Be sure to use the company-specified products for the separately purchased parts. Use of non-specified products may result in fire, electric shock, water leakage, etc. Have the installation performed by a professional.
- Confirm that earthing is performed correctly.

**Operation**

- Before opening the electrical control cover or inspection cover or maintenance cover of the Air to Air Heat Exchanger with DX Coil Unit, set the circuit breaker to the OFF position. Failure to set the circuit breaker to the OFF position may result in electric shocks through contact with the interior parts. Only a qualified installer(\*1) or qualified service person(\*1) is allowed to remove the electrical control cover or inspection cover or maintenance cover of the Air to Air Heat Exchanger with DX Coil Unit and do the work required.
- Inside the Air to Air Heat Exchanger with DX Coil Unit are high-voltage areas and rotating parts. Due to the danger of electric shocks or of your fingers or physical objects becoming trapped in the rotating parts, do not remove the electrical control cover, inspection cover or maintenance cover of the Air to Air Heat Exchanger with DX Coil Unit. When work involving the removal of these parts is required, contact a qualified installer or a qualified service person.
- Do not modify the products. Do not also disassemble or modify the parts. It may cause a fire, electric shock or injury.
- Use of a stand more than 50 cm high to clean the filter or heat exchange element of the Air to Air Heat Exchanger with DX Coil Unit or to carry out other such jobs constitutes working at heights. Due to the danger of falling off the stand and injuring yourself while working at heights, this kind of work should not be done by unqualified individuals. When this kind of work must be carried out, do not do it yourself but ask a qualified installer(\*1) or a qualified service person(\*1) to do it for you.
- Do not touch the aluminum fin of the Air to Air Heat Exchanger with DX Coil Unit or outdoor unit. You may injure yourself if you do so. If the fin must be touched, do not touch it yourself but contact a qualified installer(\*1) or a qualified service person(\*1).
- Never insert your finger or a stick into the air intake or outlet.  
Doing so may result injury as the fan is rotating at high speed inside the unit.
- Be sure to stop running the Air to Air Heat Exchanger with DX Coil Unit and turn off the breaker before cleaning. Otherwise, injury may result as the fan is rotating at high speed inside the unit.
- Do not run or stop running the unit when flammable gas is leaking.  
A gas explosion may occur. Open the window to ventilate the room if flammable gas is leaking.

**Repairs**

- When you have noticed that some kind of trouble (such as when an error display has appeared, there is a smell of burning, abnormal sounds are heard, the Air to Air Heat Exchanger with DX Coil Unit falls to cool, heat or water is leaking) has occurred in the Air to Air Heat Exchanger with DX Coil Unit, do not touch the Air to Air Heat Exchanger with DX Coil Unit yourself but set the circuit breaker to the OFF position, and contact a qualified service person(\*1). Take steps to ensure that the power will not be turned on (by marking "out of service" near the circuit breaker, for instance) until qualified service person arrives. Continuing to use the Air to Air Heat Exchanger with DX Coil Unit in the trouble status may cause mechanical problems to escalate or result in electric shocks, or other failure.
- If you have discovered that there is a danger of the Air to Air Heat Exchanger with DX Coil Unit's falling, do not approach the Air to Air Heat Exchanger with DX Coil Unit but set the circuit breaker to the OFF position, and contact a qualified installer(\*1) or a qualified service person(\*1) to refit the unit. Do not set the circuit breaker to the ON position until the unit has been refitted.
- Do not move or repair any unit by yourself. Since there is high voltage inside the unit, you may get electric shock when removing the cover and main unit.
- Do not modify the products. Do not also disassemble or modify the parts. It may cause a fire, electric shock or injury.

**Relocation**

- When the Air to Air Heat Exchanger with DX Coil Unit is to be relocated, do not relocate it yourself but contact a qualified installer(\*1) or a qualified service person(\*1). Failure to relocate the Air to Air Heat Exchanger with DX Coil Unit properly may result in electric shocks and/or a fire.
- Do not touch any switches with wet finger, otherwise you may get an electric shock.

(\*1) Refer to the "Definition of Qualified Installer or Qualified Service Person."

**⚠ CAUTION****TO DISCONNECT THE APPLIANCE FROM THE MAINS SUPPLY**

- Means for disconnection having a contact separation in all poles at least 3 mm must be incorporated in the fixed wiring in accordance with the wiring rules.

**THE INSTALLATION FUSE (All types can be used) MUST BE USED FOR THE POWER SUPPLY LINE OF THIS Air to Air Heat Exchanger with DX Coil Unit.****CAUTIONS ABOUT INSTALLATION (Be sure to confirm the following cautions.)**









- Certainly lay the drain hose for perfect draining. Bad drainage may cause flooding in the house and getting furniture wet.
- Make sure to connect the Air to Air Heat Exchanger with DX Coil Unit to an exclusive power supply of the rated voltage, otherwise the unit may break down or cause a fire.

**CAUTIONS ABOUT OPERATION**

- Do not use this Air to Air Heat Exchanger with DX Coil Unit for special purpose such as preserving food, precision instruments, art objects, breeding animals, car, vessel, etc.
- If the Air to Air Heat Exchanger with DX Coil Unit will not be used for a considerably long time, turn off the main switch or the circuit breaker, for safety.
- To make the Air to Air Heat Exchanger with DX Coil Unit operate in its original performance, operate it within the range of the operating temperature specified in the instructions. Otherwise it may cause a malfunction, or water leak from the unit.
- Prevent any liquid from falling into the remote controller. Do not spill juice, water or any kind of liquid.
- Do not leave flammable sprays or other flammable materials near the Air to Air Heat Exchanger with DX Coil Unit, and do not spray flammable aerosol directly to the Air to Air Heat Exchanger with DX Coil Unit. They may catch fire.
- Do not pour or spray water or detergent on the electric parts.  
Doing so may cause electric leakage and result in a fire, electric shocks and/or injury.
- Do not install the unit and inside air intake in a place such as a machine factory, chemical plant, or research institute, where acids, alkaline, organic solvents, or coating materials are handled and toxic gases and/or corrosive gases may be produced.  
Otherwise, gas poisoning may occur and/or the inside of the unit may be eroded or deteriorated. The deterioration and erosion may result in a fire.
- Do not use the unit in a place where it is hot (40°C or higher) or where much oily smoke is produced, and do not directly expose the unit to flame.  
Doing so may result in a fire.
- Do not expose animals or plants to the wind from the unit.  
Doing so may harm the animal or plant.
- Do not use a flammable spray near the unit or inside air intake.  
Doing so may result in a fire.
- Fix the parts such as the inspection cover firmly.
- Confirm that the outdoor unit and the heat storage unit are fixed on the base securely.  
Inappropriate fixing may cause them to fall down and an accident may result.
- Stop running the unit if it vibrates abnormally.  
The unit or parts of it may fall and an injury may result.

## Information on the Transportation, Handling and Storage of the Carton

### Examples of indication on the carton

Symbol	Description	Symbol	Description
	Keep dry	 2 cartons	Stacking height (3 cartons can be stacked in this case)
	This side up		Do not step
	Handle with care	 91 kg	Weight
	Do not roll		Do not clamp

Other cautions	Description
 <div style="border: 1px solid black; padding: 5px; display: inline-block;"> <p><b>Caution</b> Injury possibility. Don't handle with packing band, or may get injured in case of broken band.</p> </div>	<p><b>CAUTION</b> Injury possibility. Don't handle with packing band, or may get injured in case of broken band.</p>

## 2 Part Names

### Air to Air Heat Exchanger with DX Coil Unit

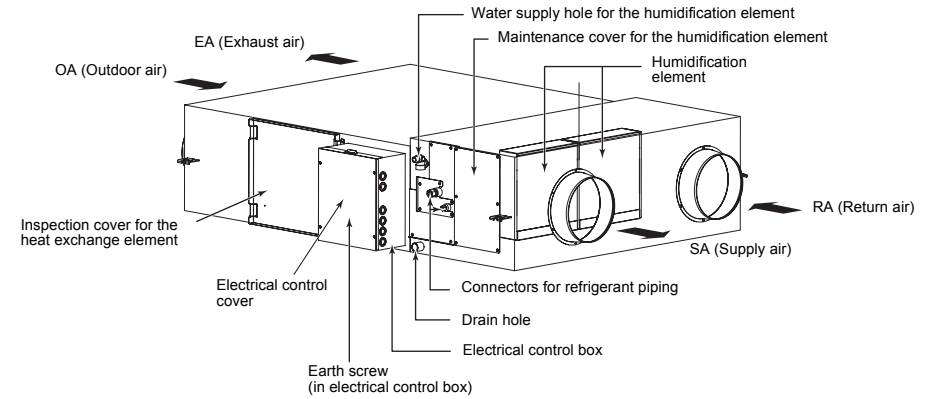

### Separately sold parts

#### Remote controller for the Air to Air Heat Exchanger with DX Coil Unit (NRC-01HE)

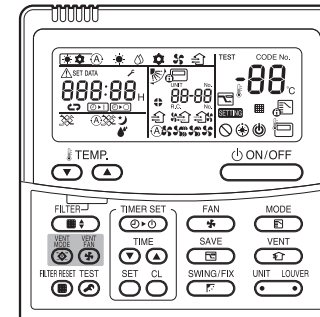

# 3 System Configuration

The control method of this product differs depending on the system configuration. Operate it following the methods explained in the system configuration examples below.

- For the actual system configuration, ask your dealer or the installer of the product for information.
- Refer also to the installation manuals and owner's manuals of the remote controllers.
- If a central remote controller is used, refer also to its installation manual and owner's Manual.

System example	Operation	Note
<p><b>A. Air to Air Heat Exchanger with DX Coil Unit system</b></p>	<p>The remote controller can be used to ON/OFF running the Air to Air Heat Exchanger with DX Coil Unit.</p> <p><b>Remote controller for the Air to Air Heat Exchanger with DX Coil Unit (NRC-01HE)</b></p> <p>The remote controller can be used to select the operation mode, start and stop the unit, control the ventilation FAN speed, select the ventilation mode, and adjust the temperature.</p> <p><b>Main remote controller (RBC-AMT32E)</b></p> <ul style="list-style-type: none"> <li>• The remote controller can be used to select the operation mode, start and stop the unit, and adjust the temperature.</li> <li>• The remote controller cannot be used to change the ventilation FAN speed or select ventilation mode.</li> </ul>	<p>If two remote controllers are used, the latter operation overrides the former and their indications always reflect the result of the latter operation.</p>
<p><b>B. Air to Air Heat Exchanger with DX Coil Unit system linked with air conditioners</b></p>	<p>The remote controller can be used to ON/OFF running the Air to Air Heat Exchanger with DX Coil Unit.</p> <p><b>Remote controller for the Air to Air Heat Exchanger with DX Coil Unit (NRC-01HE)</b></p> <p>The remote controller can be used to select the operation mode, start and stop the unit, control the ventilation FAN speed, and adjust the temperature.</p> <p><b>Main remote controller (RBC-AMT32E)</b></p> <ul style="list-style-type: none"> <li>• The remote controller can be used to select the operation mode, start and stop the unit, and adjust the temperature.</li> <li>• The remote controller cannot be used to change the ventilation FAN speed or select the ventilation mode.</li> </ul> <p>• The remote controller (NRC-01HE) can be used to start and stop only the Air to Air Heat Exchanger with DX Coil Unit. For this operation, it is necessary to change the settings. Consult the dealer for details.</p>	<p>If two remote controllers are used, the latter operation overrides the former and their indications always reflect the result of the latter operation.</p>

System example	Operation	Note
<p><b>C. Central control system</b> (When controlling the Air conditioner and the Air to Air Heat Exchanger with DX Coil Unit separately)</p>	<p>The central controller can be used to ON/OFF the whole system and separately ON/OFF groups of Air conditioners and the Air to Air Heat Exchanger with DX Coil Units.</p> <p>The central controller cannot be used to control the ventilation FAN speed or select the ventilation mode of the Air to Air Heat Exchanger with DX Coil Unit.</p> <p>* Use NRC-01HE or RBC-AMT32E to control only the group of the Air to Air Heat Exchanger with DX Coil Unit. You cannot control the ventilation FAN speed or select the ventilation mode when using RBC-AMT32E.</p>	<p>If two control devices are used; the central controller and the remote controllers for the Air to Air Heat Exchanger with DX Coil Unit and Air conditioner, the latter operation overrides the former regardless of which device is used.</p>
<p><b>D. Central control system</b> (When controlling the Air conditioner and the Air to Air Heat Exchanger with DX Coil Unit together)</p>	<p>The central controller can be used to ON/OFF the whole system.</p> <p>The central controller cannot be used to control the ventilation FAN speed or select the ventilation mode of the Air to Air Heat Exchanger with DX Coil Unit.</p> <p>The remote controller (NRC-01HE) can be used to control the ventilation FAN speed and select the ventilation mode of the Air to Air Heat Exchanger with DX Coil Unit.</p> <p>The remote controller (RBC-AMT32E) cannot be used to control the ventilation FAN speed or select the ventilation mode of the Air to Air Heat Exchanger with DX Coil Unit.</p> <p>* The remote controller (NRC-01HE) can be used to start and stop only the Air to Air Heat Exchanger with DX Coil Unit. For this operation, it is necessary to change the settings. Consult the dealer for details.</p>	<p>If two remote controllers are used, the latter operation overrides the former and their indications always reflect the result of the latter operation.</p>

\* When the Air to Air Heat Exchanger with DX Coil Unit system linked with indoor air conditioners is used, set the Air to Air Heat Exchanger with DX Coil Unit as "Follower", referring to "Setting the address manually using the remote controller" in the Installation Manual of the outdoor unit.

## 4 Part Names and Functions of the Remote Controller

### Remote controller for the Air to Air Heat Exchanger with DX Coil Unit (NRC-01HE)

#### Operation section

- One of these remote controllers can be used to control both indoor air conditioner units and Air to Air Heat Exchanger with DX Coil Units (up to 8 units in total).
- After setting the operation conditions, you can use the units by just pressing the ON/OFF button.
- Functions concerning controlling the Air to Air Heat Exchanger with DX Coil Unit are explained here. For controlling an air conditioner, refer to the owner's manuals supplied with the remote controller and the air conditioner.

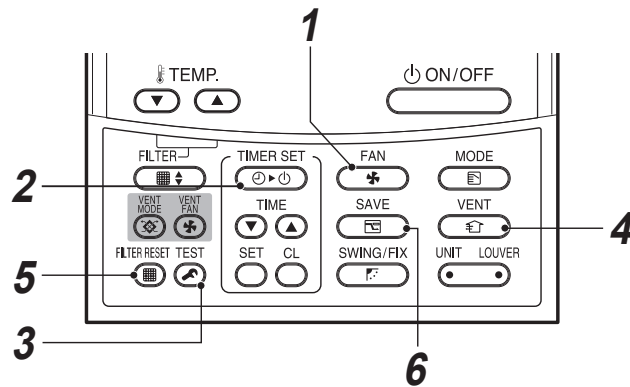
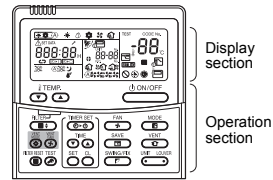

**1** **button (Fan speed select button) (\*1)**

**2** **button (Timer set button)**  
Used for timer setting

**3** **button (Test button)**  
Used for service.  
Do not use this button in everyday operations.

**4** **button (\*1) (Ventilation button)**  
This button is used when the Air to Air Heat Exchanger with DX Coil Unit is in a system linked with air conditioners. Push the button to turn on/off the Air to Air Heat Exchanger with DX Coil Unit. Turning on/off the air conditioner also turn on/off the Air to Air Heat Exchanger with DX Coil Unit.

\* No Air to Air Heat Exchanger with DX Coil Unit is connected or separate operation of the Air to Air Heat Exchanger with DX Coil Unit is not set, if "⊘" appears on the remote controller display after pushing the button.

**5** **button (Filter reset button)**  
Resets "FILTER" indication after cleaning.

**6** **button (Power save operation)**  
Use to initiate power saving mode.

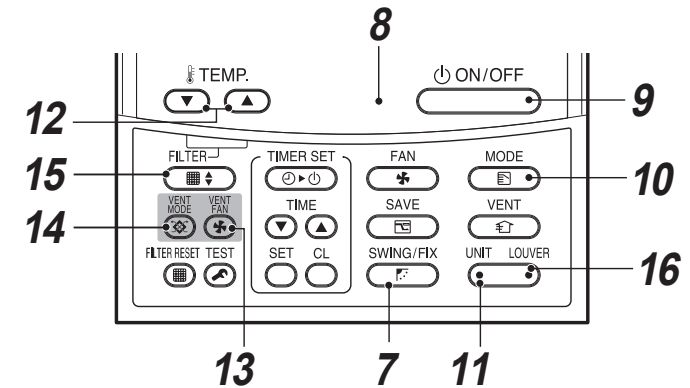

**7** **button (Swing/Louver direction button) (\*1)**

**8** **Operation lamp**  
Lights up during operation.  
Blinks when an error occurs or the protective device activates.

**9** **button**  
Turns on the unit when pressed, and turns it off when pressed again.

**10** **button (Operation mode select button)**  
Selects desired operation mode.

**11** **button (Unit select button)**  
Used for selecting a unit while changing settings if the remote controls two or more units.

**12** **button (Temperature set button)**  
Adjusts the set temperature.  
Select the desired set point by pushing TEMP. or TEMP.

**13** **button (Ventilation fan speed button)**  
Used to select the ventilation fan speed

**14** **button (Ventilation mode button)**  
Used to select a ventilation mode.

**15** **button (Filter elevating button) (\*1)**

**16** **button (Louver select button) (\*1)**

#### OPTION:

##### Remote controller sensor

Normally the temperature sensor of the indoor unit senses the temperature. The temperature around the remote controller can also be sensed. For details, contact your dealer.

\* Do not use the function when the air conditioner is controlled in a group.

(\*1):

This function is not available for Air to Air Heat Exchanger with DX Coil Unit.

"⊘" will be displayed for few seconds when the unit is running in a system equipped with only the Air to Air Heat Exchanger with DX Coil Unit.

## ◆ Display section

All indicators are displayed on the display example below for explanation. In reality, only the selected options will be displayed. Indications concerning controlling the Air to Air Heat Exchanger with DX Coil Unit are explained here. For indications concerning an air conditioner, refer to the owner's manuals supplied with the remote controller and the air conditioner.

- **SETTING** blinks on the display of the remote controller when the power switch is turned on for the first time.  
The initial settings progress while **SETTING** is blinking. Start to use the remote controller after **SETTING** has disappeared.

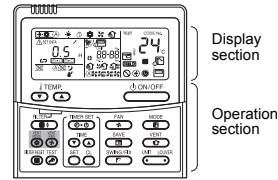

### NOTE

The LCD may temporarily be blurred due to static electricity.

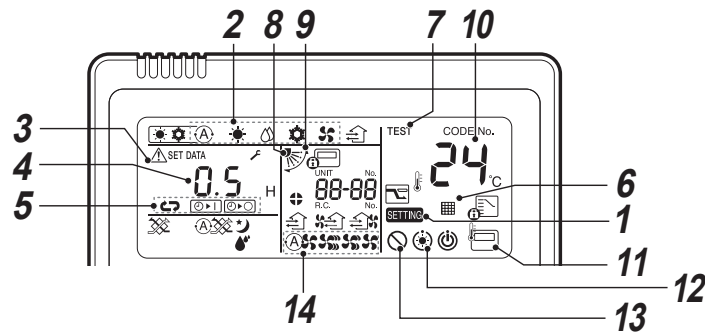

#### 1 SETTING indicator

Displayed when setting the timer or other functions.

#### 2 Operation mode indicator

Indicates the operation mode selected.





#### 3 Error indicator

Displayed when the protective device activates or an error occurs.

#### 4 Time indicator

Indicates time concerning the timer.  
(Indicates a error code when an error occurs.)

#### 5 Timer mode indicator

Each time you press the  button, the indication changes as follows: , , , and no timer indication.

#### 6 Filter indicator

Reminder to clean the air filter.

#### 7 Test run indicator

Displayed during a test run.

#### 8 Louver position display (\*1)

#### 9 Swing indicator (\*1)

#### 10 Set temperature display

The selected set temperature is displayed.

#### 11 Remote controller sensor indicator

Displayed when the remote controller sensor is used.

#### 12 Pre-heat indicator





Displayed when the heating mode is energized or defrost cycle is initiated.  
While this indication is displayed, the indoor fan stops or operate in fan mode.

#### 13 No function indicator

Displayed when the function requested is not available on that model.

#### 14 Fan speed indicator (\*1)

Indicates the selected fan speed:

(Auto)	
(High)	
(Medium)	
(Low)	

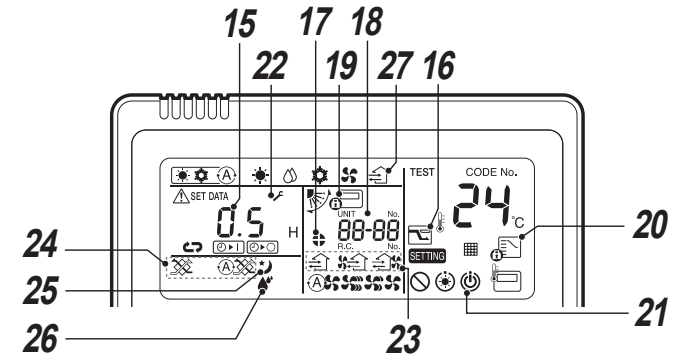

#### 15 Louver Number display. (\*1)

#### 16 Power saving mode display



Displayed during capacity saving mode.

#### 17 Louver lock indicator (\*1)

#### 18 UNIT No. indicator

The number of the Air to Air Heat Exchanger with DX Coil Unit selected using the UNIT button or that of the unit in which an error has occurred.

#### 19 Central control indicator

Displayed when a central control device such as a central controller is also used. If the central control device prohibits the use of local remote controllers,  blinks when any of the ,  or TEMP. buttons are pressed and the operation is rejected.  
The items controllable with the remote differ depending on the mode of central control. Refer to the owner's manual of the central control device you are using for more information

#### 20 Operation mode controlled indicator

Displayed when MODE button is pushed while operation mode is fixed to cool or heat by the air conditioner administrator.





#### 21 Operation ready display (\*1)

This display appears on some models.

#### 22 Service display

Displayed while the protective device works or a trouble occurs.



#### 23 Ventilation fan speed indicator

Indicates the ventilation fan's speed. , ,  or  is indicated.  
When the remote is used to control air conditioners together with the Air to Air Heat Exchanger with DX Coil Unit as a group, VENT



FAN indicator appears (blinks) only when the button  is pressed.

(High) 

(Low) 

(SA > EA)  (\*2) ) \* Displayed when the setting is activated.  
(SA < EA)  (\*2)

#### 24 Ventilation mode indicator

Indicates the selected ventilation mode.  or  is indicated.

(Automatic mode) 

(Heat exchange mode) 

#### 25 Nighttime heat purge indicator

Displayed during the nighttime heat purge operation. (\*2)

#### 26 Humidification indicator

Displayed during humidifying.

#### 27 Ventilation indicator

If the remote is used to control the Air to Air Heat Exchanger with DX Coil Unit in a system linked with air conditioners, and separate operation of the unit is set to available, the indicator is displayed while the unit is running.

\* The indicator is not displayed when the unit is running in a system equipped with only the Air to Air Heat Exchanger with DX Coil Unit.

(\*1):  
Not displayed. These functions are not available for Air to Air Heat Exchanger with DX Coil Unit.

(\*2):  
Displayed when these operation modes are activated.



# 5 How to Use

## ■ When using the remote controller for the Air to Air Heat Exchanger with DX Coil Unit (NRC-01HE)

When you use the Air to Air Heat Exchanger with DX Coil Unit for the first time or change the settings, operate the remote following the procedure below.  
From the next time, the unit starts running following the operation conditions you set by just pressing the  button.

### ◆ Preparation

#### Turning on the circuit breaker

When turned on, the separation lines appear and **SETTING** blinks on the display of the remote controller.

- \* The remote controller will not work for about 1 minute after turning on the power. This is not a malfunction.
- \* To use a Air to Air Heat Exchanger with DX Coil Unit system linked with air conditioners, turn on the circuit breaker for the air conditioners too.

#### REQUIREMENT

- Keep the circuit breaker turned on during use.
- For the Air to Air Heat Exchanger with DX Coil Unit system linked with air conditioners, when the system is used after a long period of disuse, turn on the circuit breaker of the unit and air conditioners 12 hours or more before starting operation.

## ■ Operations

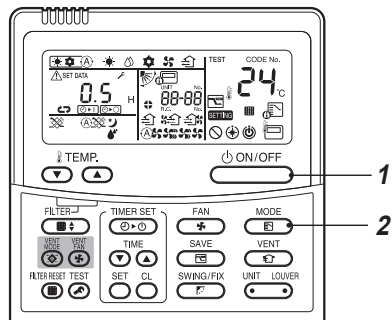

- 1 Press the  buttons to start operation.  
The operation lamp lights up.

#### REQUIREMENT

When the Air to Air Heat Exchanger with DX Coil Unit is in a system linked with air conditioners, they start running at the same time.

- 2 Push the “MODE  ” button to select a operation mode.

Each time the button is pushed, the operation mode and its icon change in the following order:

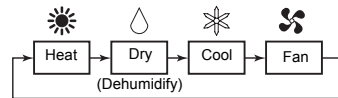



- 3 Press the  buttons to stop operation.  
The operation lamp turns off.

## ■ Changing ventilation fan speed

- 1 Push the  button to select the ventilation fan speed.

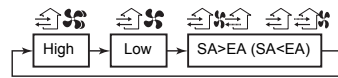
Each time the button is pushed, the speed and indication changes as follows.



- \* The indications  and  are displayed only when the air volume imbalance setting is activated.

#### REQUIREMENT



As factory default, the air volume imbalance setting is deactivated only [High] and [Low] are available for selection. Consult your dealer to activate the setting.

## About air volume imbalance ( [SA>EA]/ [SA<EA])

### For normal ventilation (High or Low):

The volumes of the indoor air supply and outdoor air exhaustion are set to the same level.

### For volume ventilation imbalance:

- When  [SA>EA] is selected: the volume of the indoor air supply is larger than that of the outdoor air exhaustion.  
(Inflow of humidity and smells from the toilet and kitchen is reduced.)
  - When  [SA<EA] is selected: the volume of the outdoor air exhaustion is larger than that of the indoor air supply.  
(Outflow of smells and floating bacteria into a corridor or other places is reduced.)
- \* Consult your dealer if the setting of the air volume imbalance seems incorrect.

## ■ Changing ventilation mode

- 1 Push the  button to select a ventilation mode.

Each time the button is pushed, the ventilation mode and indication change as follows:

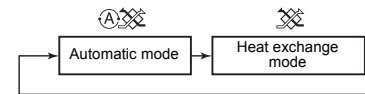

## About ventilation modes



The unit has two ventilation modes.

- **Automatic mode**  
The heat exchange mode and the bypass mode\* are automatically switched between according to the operation mode (cooling, heating, dry, ventilation), setting temperature, or information from the indoor/outdoor thermo sensor of the Air to Air Heat Exchanger with DX Coil Unit.
- **Heat exchange mode**  
Exchanging heat between the outdoor and indoor air and making the temperature and humidity of the outdoor air closer to those of the indoor air before supplying it.
- **Bypass mode (unavailable)**  
Outdoor air is taken into a room as it is. This mode is mainly used in spring and summer.

## ⚠ CAUTION





If the outdoor temperature falls to 15°C or below in [Automatic mode] the system will automatically start to run in [Heat exchange mode] regardless of the mode setting to prevent condensation in the Air to Air Heat Exchanger with DX Coil Unit.  
\* The indication of the ventilation mode setting does not change.

## ■ Changing the set temperature



- 1 Push the “TEMP.  ” buttons.  
Push  to increase the temperature, and  to decrease the temperature. (The set temperature cannot be changed in the fan mode.)

## ■ About the separate operation of the Air to Air Heat Exchanger with DX Coil Unit in a system linked with air conditioners

\* The procedure below is not effective in a system equipped with the Air to Air Heat Exchanger with DX Coil Unit only.



- 1 Press the  button while the system is running.  
Only the Air to Air Heat Exchanger with DX Coil Unit stops and the  indicator turns off.
- 2 Press the  button while the system is stopped.  
The  indicator lights up and the Air to Air Heat Exchanger with DX Coil Unit starts running separately.



#### NOTE

- Normally, the Air to Air Heat Exchanger with DX Coil Unit ON/OFF as the air conditioner is ON/OFF when it is in a system linked with air conditioners.
- If “” is displayed when the  button is pushed, change certain settings is necessary to operate the unit separately. Consult your dealer to change the settings.

### About nighttime heat purge operation

- Nighttime heat purge is a function to reduce the room air conditioning load in the morning in summer by exhausting the air indoor which has become warm while the air conditioner is stopped in the night automatically in the Bypass mode.

- The nighttime heat purge operation functions if night purge is activated and the last operation mode of the air conditioner before stopping is ,  or  in an Air to Air Heat Exchanger with DX Coil Unit system linked with air conditioners.

If the  button is pushed while the system is running, the operation lamp turns off,  appears on the display, and the nighttime heat purge operation turns on-standby.

After the operation becomes on-standby, the unit automatically starts ventilation in [Low] ventilation fan speed and [Bypass mode] when the conditions to start the nighttime heat purge operation below are fulfilled.

The nighttime heat purge operation is paused for one hour if any of the conditions to pause the operation are detected.

If the conditions to start the nighttime heat purge operation are fulfilled one hour after the pause, the operation will start again. If not, the operation will remain paused for one more hour.

This cycle is repeated until the conditions to stop (end) the nighttime heat purge operation below are fulfilled.

#### The conditions to start the nighttime heat purge operation

The unit compares temperatures indoor and outdoor using the monitoring operation (for about 5 minutes) and will start the nighttime heat purge operation if the following conditions are fulfilled.

1. A certain amount of time has passed between the nighttime heat purge operation becoming on-standby and the monitoring operation starting. (The time is set between 1- 48 hours in 1 hour steps.)
2. The indoor temperature is 3°C or more higher than the outdoor temperature and the indoor temperature is 2°C or more higher than the temperature set for the operation.

#### The conditions to pause the nighttime heat purge operation (the operation pauses for one hour.)



1. The indoor temperature is the same or lower than the outdoor temperature, the indoor temperature is the same or lower than the temperature set for the operation, or one hour has passed since the nighttime heat purge operation started.

#### The conditions to stop (end) the nighttime heat purge operation

The nighttime heat purge operation ends and the  indicator disappears if any of the following conditions are fulfilled.

1. The air conditioner or Air to Air Heat Exchanger with DX Coil Unit is started.
2. 48 hours has passed since the monitoring operation started.

#### NOTE

- The setting of the nighttime heat purge operation is "OFF" As factory default. Consult your dealer to change the setting to "ON" or the setting of the time until the monitoring operation starts.
- The settings of  or  cannot be changed during the nighttime heat purge operation. Their indicators are not displayed.
- The  indicator stays lit while the operation is on-standby or paused.
- The nighttime heat purge operation cannot be activated if 24-hour ventilation is activated.

### CAUTION

The nighttime heat purge operation is not executed if the outdoor temperature becomes about 15°C or less to prevent condensation in the Air to Air Heat Exchanger with DX Coil Unit, but the  indicator is still lit.

### About humidifying

Humidifying is available during heating.

#### REQUIREMENT

- When the humidifying season is over, perform the drying operation for the humidifier. Even during humidifying season, perform the drying operation if the unit is not used for a long period of time (over a couple of weeks). The drying operation must be performed in ventilation mode for over 24 hours. Failure to perform the drying operation may cause residual water to rot down and emit an unpleasant odor.
- It is required to replace the humidifying element if it emits such an odor.
- During humidifying season, when running only this unit while all the other air-conditioners in the room are stopped, change the heating mode to the ventilation mode, and stop the humidifying operation. Continuing the humidifying operation may increase the temperature and create condensation.

#### To use the Air to Air Heat Exchanger with DX Coil Unit effectively, observe the following conditions.

Cooling operation	Outdoor temperature range	-5°C to +43°C
	Room temperature range	+21°C to +32°C
	Room humidity	80% or less If the Air to Air Heat Exchanger with DX Coil Unit continues running for a long time with the room humidity over 80%, water droplets may fall from the unit or may be emitted from the air outlet.
Heating operation	Outdoor temperature range	-15°C to +21°C
	Room temperature	+28°C or less

- \* If the Air to Air Heat Exchanger with DX Coil Unit is continuously operated beyond the conditions above, the protective device will be activated and force the unit to stop.

## 6 Timer Operation

Select a timer type from the following three: (Max. 168 hours)

- OFF timer** : Stops running after a specified period.
- Repeat-OFF timer** : Stops running after a specified period every time you use the unit.
- On timer** : Starts running after a specified period.

### Setting the timer

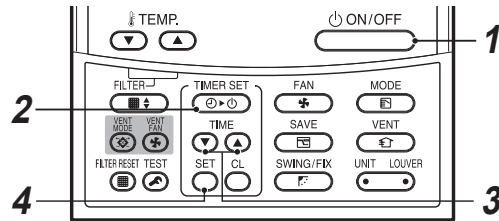

**1** Push the **ON/OFF** button to start operation.  
The operation lamp lights up.

**2** Push the **TIMER SET** button.  
Each time the button is pushed, the timer mode and indication change in the following order:

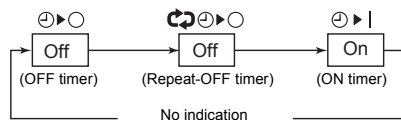

**SETTING** and the time indication blink.

**3** Press the **TIME** buttons to set the period of time until the timer actions.

- The time setting increases in 0.5-hour (30 minute) increments each time you press **▲**. The setting increases in 1-hour increments if it is over 1 day (24 hours). The maximum is 7 days (168 hours).  
On the remote controller, settings between 0.5 hours and 23.5 hours (\*1) are displayed as is. For settings over 24 hours (\*2), the days and hours are displayed.
- The time setting decreases in 0.5-hour (30 minute) decrements (0.5 hours to 23.5 hours) or 1-hour decrements (24 hours to 168 hours) each time you press **▼**.

**Example of indication on the remote controller**

- **23.5 hours (\*1)**

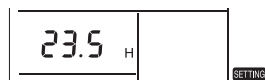

- **34 hours (\*2)**

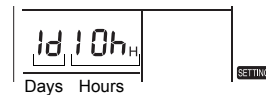

**1d** indicates 1 day (24 hours).  
**10h** indicates 10 hours.  
(Total: 34 hours)

**4** Press the **SET** button.

- **SETTING** disappears, the time indication is displayed, and **▶|** or **▶○** flashes. (When using the ON timer, all indications other than the time indication and **▶|** turn off.)

### cancelling the timer

**1** Press the **ON/OFF** button.  
The timer indicator disappears.

#### NOTE

- When using the Repeat-OFF timer, pressing the **ON/OFF** button after the unit has been stopped by the timer starts it running again, and the unit will stop again after the specified period.
- The nighttime heat purge operation is activated, the unit is running the activated operation while the unit stops following the timer setting.

## 7 Installation

### Location

- Do not install the unit in places where the outside temperature falls below 5°C.
- Avoid installing near machines emitting high frequency waves.
- Not suitable for chemical plants such as liquefied carbon dioxide refrigerant plants.
- A failure may occur in certain locations such as the following:
  - Areas with large amount of oil droplets (including machine oil) or vapors
  - Salty areas near oceans, etc.
  - Hot springs emitting sulfidizing gas, etc.
  - Heavily acidic or alkaline places.

Special maintenance or parts are required for use in the above places. For details, contact the dealer where you purchased the product.

- Leave an enough space around the air intake and outlet of the outdoor unit so that the ventilation is not restricted.
- Avoid places where strong wind may blow against the air intake and discharge of the outdoor unit.
- Attach a snow stand, snow hood, etc. to the outdoor unit for use in snowfall areas. For details, contact the dealer where you purchased the product.
- Make sure drain water from the outdoor unit is emitted into places with good drainage.
- Confirm that the filters for the heat transfer element and the medium efficiency particulate air filter are attached. If they are not attached, the heat transfer element or the heat exchanger will become clogged with dust, deteriorating the performance and possibly causing water leakage.
- Keep a distance of at least 1 m between the Air to Air Heat Exchanger with DX Coil Unit/remote controller and a TV or radio. Failure to observe this precaution may cause visual disturbance or noise.
- Leave a distance of at least 1.5 m between the air outlet and a fire alarm. If this precaution is not observed, the alarm may not work properly or detect fire in case of fire.

### Be careful of operation sounds

- Locate the unit in a place secure enough so that the sounds and vibrations do not increase.
- If something is placed near the air discharge of the outdoor unit, noise may increase.
- Do not disturb your neighbors with cool/warm air or noise coming from the air discharge of the outdoor unit.

## 8 Air Conditioner Operations and Performance

### ■ Check before operation

- Turn on the power switch at least 12 hours before starting operation.
- Connect the earth wire securely.
- Attach the air filter to the indoor unit.

### ■ Defrosting during heating

- If frost falls on the outdoor unit during heating, defrosting is automatically performed (for approximately 2 - 10 minutes) to increase the heating effect.

### ■ 3-minute protection

The outdoor unit will not operate for approximately 3 minutes after the air conditioner has been immediately restarted after stopping, or the power switch has been turned on. This is to protect the system.

### ■ Power failure

- In the case of a power failure, all operations stop.
- To resume operations, push the ON/OFF button.

### ■ Fan rotation of a stopped indoor unit

- While other indoor units operate, the fans on indoor units in stand-by mode rotate for several minutes approximately once per one hour to protect the machines.

### ■ Protective device (High pressure switch)

The high pressure switch stops the Air to Air Heat Exchanger with DX Coil Unit automatically when excessive load is applied to the Air to Air Heat Exchanger with DX Coil Unit.

If the protective device activates, the unit's running stops and the operation lamp blinks.

When the protective device activates, the  indicator and the check code are displayed on the remote controller.

The protective device may activate in the following cases:

#### During cooling

- When the air intake or air discharge of the outdoor unit is blocked.
- When strong wind blows continuously against the air outlet of the outdoor unit.

#### During heating (for heat-pump model only)

- When dust or dirt is excessively adhered to the air filter of the indoor unit.
- When the air outlet of the indoor unit is blocked.

#### NOTE

When the protective device activates, turn off the power switch, remove the cause, and then restart running.

### ■ Cooling/Heating operations

Each unit can be controlled individually. However, indoor units connected to the same outdoor unit cannot perform cooling and heating simultaneously.

When you attempt simultaneous operation, indoor units performing cooling are stopped, and the running preparation indicator  is displayed on the remote controller.

An indoor unit performing heating continues running. When you attempt an operation without the configured settings, the running preparation indicator  is displayed on the remote controller and operation stops. If operation is fixed to cooling or heating by the Air to Air Heat Exchanger with DX Coil Unit administrator, only the configured settings apply to the operation.

### ■ Heat exchange element

A smell may be emitted from the heat transfer element during the initial stages of use. This is neither a malfunction nor harmful.

## 9 Maintenance

### ■ Maintenance of the filter, heat exchange element, and humidifier

#### ⚠ WARNING

Cleaning the filter, heat exchange element, humidifier element and other parts involves dangerous work in high places. Ask a qualified installer or service person to do it.



Do not attempt it by yourself.

#### ⚠ CAUTION

Do not push buttons with wet hands.

Doing so may result in electric shock.

#### ◆ Filter maintenance

- 1 Clean the filter if “” is indicated on the remote controller.
- 2 Press the “” button after cleaning the filter. The “FILTER RESET” indicator disappears.

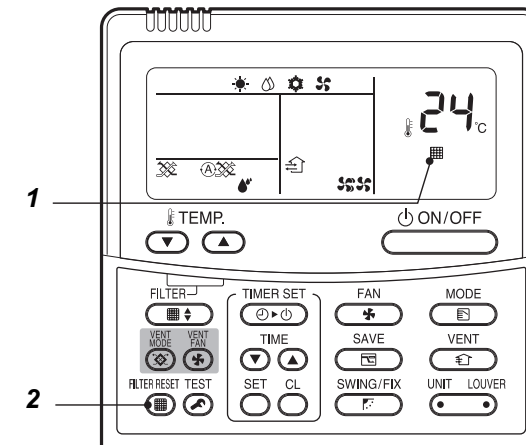

#### ⚠ CAUTION

##### Cleaning remote controller

- Use a dry cloth to wipe the remote controller.
- Do not use a damp cloth on the remote controller.
- Do not use a chemically-treated duster for wiping or leave such materials on the unit for long. It may damage or fade the surface of the unit.
- Do not use benzine, thinner, polishing powder, or similar solvents for cleaning. These may cause the plastic surface to crack or deform.

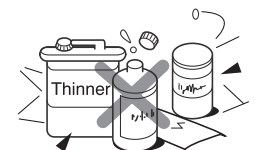

### ■ Maintenance of the humidifier element

The replacement cycle of the humidifier element varies greatly depending on the conditions of use. Refer to the cycles below as general replacement cycles. (They are not the terms of guarantee.)

When the water hardness is 25 mg/L	Every 5 years
When the water hardness is 50 mg/L	Every 3 years
When the water hardness is 100 mg/L	Every 2 years

- The humidifying performance deteriorates gradually as impurities in tap water are accumulated in the humidifying element.
- In general, replace the humidifying element when the humidifying performance of the element has deteriorated by 20 to 40% compared with that of a new one.
- Estimated operating hours: 10 hours per day X 20 days per month X 5 months per year = 1000 hours per year
- The amount of impurities accumulated in the humidifying element is largely dependent on the water quality (water hardness, the variety or amount of impurities, the pH of the water, water temperature, etc.) or conditions of use.

# 10 When the Following Symptoms are Found

Check the points described below before asking repair servicing.

		Symptom	Cause
It is not a failure.	Indoor unit	<ul style="list-style-type: none"> <li>• "Swish" sound is heard sometimes.</li> <li>• Slight clacking sound is heard.</li> <li>• "Ⓜ" indication is lit.</li> <li>• "Ⓜ" indication is lit.</li> <li>• "Ⓜ" indication is lit.</li> <li>• Sound or cool air is output from the stand by indoor unit.</li> <li>• When power of the Air to Air Heat Exchanger with DX Coil Unit is turned on, "Ticktock" sound is heard.</li> <li>• LCD blurs when it is touched.</li> </ul>	<ul style="list-style-type: none"> <li>• When the operation has started, during the operation, or immediately after the operation has stopped, a sound such as water flows may be heard, and the operation sound may become larger for 2 or 3 minutes immediately after the operation has started. They are flowing sound of refrigerant or draining sound of dehumidifier.</li> <li>• This is sound generated when heat exchanger, etc. expand and contract slightly due to change of temperature.</li> <li>• When cooling operation cannot be performed because another indoor unit performs heating operation.</li> <li>• Is outdoor temperature out of operation temperature range?</li> <li>• When the manager of the Air to Air Heat Exchanger with DX Coil Unit has fixed the operation to COOL or HEAT, and an operation contrary to the setup operation is performed.</li> <li>• When stopping the fan to prevent cool air blow at starting heating.</li> <li>• Since refrigerant is flowed temporarily to prevent stay of oil or refrigerant in the stand by indoor unit, sound of flowing refrigerant, may be heard or white steam when other indoor unit operates in HEAT mode, and cold air in COOL mode may be blow-out.</li> <li>• Sound is generated when the expansion valve operates when power has been turned on.</li> <li>• LCD may temporarily blur by static electricity.</li> </ul>
		Operates or stops automatically.	<ul style="list-style-type: none"> <li>• Is the timer "ON" or "OFF"?</li> </ul>
Check again.	Does not operate.	<ul style="list-style-type: none"> <li>• Is it a power failure?</li> <li>• Is the power switch turned off?</li> <li>• Is the power fuse or breaker blown?</li> <li>• Has the protective device operated? (The operation lamp goes on.)</li> <li>• Is the timer "ON"? (The operation lamp goes on.)</li> <li>• Are COOL and HEAT selected simultaneously? ("Ⓜ" indication is lit on the display of the remote controller.)</li> <li>• Is outdoor temperature out of operation temperature range? Operation stops automatically.</li> </ul>	
	The unit runs in the ventilation mode only	<ul style="list-style-type: none"> <li>• Is outdoor temperature out of operation temperature range? When the outdoor temperature is outside the range of cooling/heating operation, the unit runs in the ventilation mode automatically.</li> </ul>	

## ⚠ CAUTION

If any of the following conditions occur, turn off the main power supply switch and immediately contact the dealer:

- Switch operation does not work properly.
- The main power fuse often blows out, or the circuit breaker is often activated.
- A foreign matter or water fall inside the Air to Air Heat Exchanger with DX Coil Unit.
- When the Air to Air Heat Exchanger with DX Coil Unit does not operate even after the cause of the protective device activation has been removed.
- Any other unusual conditions are observed.

### Confirmation and check

When an error occurred in the Air to Air Heat Exchanger with DX Coil Unit, the check code and the indoor unit No. appear on the display part of the remote controller.

The check code is only displayed during the operation.

If the display disappears, operate the Air to Air Heat Exchanger with DX Coil Unit according to the following "Confirmation of error log" for confirmation.

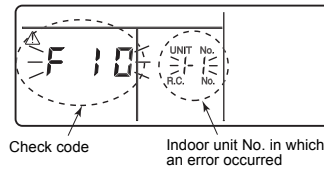

### Confirmation of error log

When an error occurred on the Air to Air Heat Exchanger with DX Coil Unit, the error log can be confirmed with the following procedure. (The error log is stored in memory up to 4 errors.)

The error can be confirmed from both operating status and stop status.

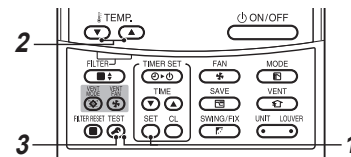

Procedure	Description
1	<p>When  and  buttons are pushed simultaneously for 4 seconds or more, the following display appears.</p> <p>If [  Service check ] is displayed, the mode enters in the error log mode.</p> <ul style="list-style-type: none"> <li>• [01 : Order of error log] is displayed in CODE No. window.</li> <li>• [Check code] is displayed.</li> <li>• [Indoor unit address in which an error occurred] is displayed in UNIT No..</li> </ul>
2	<p>Every pushing of [  /  ] button used to set temperature, the error log stored in memory is displayed in order.</p> <p>The numbers in CODE No. indicate CODE No. [01] (latest) to [04] (oldest).</p> <p><b>CAUTION</b></p> <p>Do not push  button because all the error log of the indoor unit will be deleted.</p>
3	<p>After confirmation, push  button to return to the usual display.</p>

1. Check the errors according to the above procedure.
2. Ask an authorized dealer or qualified service (maintenance) professional to repair or maintain the Air to Air Heat Exchanger with DX Coil Unit.
3. More details of the check code are explained in Service Manual.

# 11 Specifications

## ■ Model with a humidifier

		MMD-VNK502HEXE	MMD-VNK802HEXE	MMD-VNK1002HEXE	MMD-VNK1002HEXE2								
Type	Function	Cooling and heating dual purpose type											
	Unit configuration	Discrete type											
Voltage		220-240V~, 50Hz/ 220V~, 60Hz	220-240V~, 50Hz/ 220V~, 60Hz	220-240V~, 50Hz	220V~, 60Hz								
Equivalent HP		1.0	1.7	2	2								
Refrigerant		R410A											
Outdoor air thermal load handling capacity	cooling capacity (kw)	4.10(1.30)	6.56(2.06)	8.25(2.32)	8.25(2.32)								
	heating capacity (kw)	5.53(2.33)	8.61(3.61)	10.92(4.32)	10.92(4.32)								
Air Volume	m <sup>3</sup> /h	500/500	800/800	950/950	950/950								
Fan speed		Extra high High Low	Extra high High Low	Extra high High Low	Extra high High Low								
Power consumption	W	305/ 365	285/ 350	240/ 290	530/ 620	485/ 575	350/ 400	575	565	520	750	685	545
External Static Pressure	Pa	95/175	85/150	95/135	105/ 165	85/140	90/110	110	90	115	155	110	80
Humidification level	kg/h	3.0/3.0		5.0/5.0		6.0/6.0		6.0/6.0		6.0/6.0		6.0/6.0	
Sound pressure level	dB	36.5/ 39.0	35.5/ 37.0	33.5/ 35.5	40.0/ 42.0	39.0/ 41.0	38.0/ 39.0	42.0	41.0	39.0	42.5	41.0	39.0
External dimensions	Height	430				430				430			
	Width	1140				1189				1189			
	Depth	1690				1739				1739			
Weight	kg	91		111		112		114		114		114	

## ■ Model without a humidifier

		MMD-VN502HEXE	MMD-VN802HEXE	MMD-VN1002HEXE	MMD-VN1002HEXE2								
Type	Function	Cooling and heating dual purpose type											
	Unit configuration	Discrete type											
Voltage		220-240V~, 50Hz/ 220V~, 60Hz	220-240V~, 50Hz/ 220V~, 60Hz	220-240V~, 50Hz	220V~, 60Hz								
Equivalent HP		1.0	1.7	2	2								
Refrigerant		R410A											
Outdoor air thermal load handling capacity	cooling capacity (kw)	4.10(1.30)	6.56(2.06)	8.25(2.32)	8.25(2.32)								
	heating capacity (kw)	5.53(2.33)	8.61(3.61)	10.92(4.32)	10.92(4.32)								
Air Volume	m <sup>3</sup> /h	500/500	800/800	950/950	950/950								
Notch		Extra high High Low	Extra high High Low	Extra high High Low	Extra high High Low								
Power consumption	W	300/ 365	280/ 350	235/ 250	505/ 595	465/ 555	335/ 390	550	545	485	720	665	530
External Static Pressure	Pa	120/ 200	105/ 170	115/ 150	120/ 190	100/ 155	105/ 130	135	120	105	195	160	130
Sound pressure level	dB	37.5/ 40.0	36.5/ 38.0	34.5/ 36.5	41.0/ 43.0	40.0/ 42.0	38.0/ 37.0	43.0	42.0	40.0	43.5	42.0	40.0
External dimensions	Height	430				430				430			
	Width	1140				1189				1189			
	Depth	1690				1739				1739			
Weight	kg	84		100		101		103		103		103	

\* Sound Power Level is less than 70 dBA

## ***Declaration of Incorporation of Partly Completed Machinery***

Manufacturer: Toshiba Carrier Corporation  
336 Tadehara, Fuji-shi, Shizuoka-ken 416-8521 JAPAN

Representative/  
TCF holder: Toshiba Carrier UK Ltd.  
Porsham Close, Belliver Industrial Estate,  
PLYMOUTH, Devon, PL6 7DB.  
United Kingdom

Hereby declares that the machinery described below:

Generic Denomination: Air conditioner (Air to Air Heat Exchanger with DX Coil Unit)

Model/type: MMD-VNK502HEXE  
MMD-VNK802HEXE  
MMD-VNK1002HEXE  
MMD-VNK1002HEXE2  
MMD-VN502HEXE  
MMD-VN802HEXE  
MMD-VN1002HEXE  
MMD-VN1002HEXE2

Commercial name: TOSHIBA Air to Air Heat Exchanger with DX Coil Unit

Complies with the provisions of the "Machinery" Directive (Directive 2006/42/EC) and the regulations transposing into national law.

Must not be put into service until the final machinery into which it is to be incorporated has been declared in conformity with the provisions of Machinery Directive.

Complies with the provisions of the following harmonized standard:  
EN 378-2: 2008+A1:2009

### **NOTE**

This declaration becomes invalid if technical or operational modifications are introduced without the manufacturer's consent.

<b>Information according to EMC Directive 2004/108/EC</b>	
(Name of the manufacturer)	<b>TOSHIBA CARRIER CORPORATION</b>
(Address, city, country)	336 Tadehara, Fuji-shi, Shizuoka-ken 416-8521 Japan
(Name of the Importer/Distributor in EU)	Toshiba Carrier UK Ltd.
(Address, city, country)	Porsham Close, Belliver Industrial Estate, PLYMOUTH, Devon, PL6 7DB. United Kingdom

ET99915201

**TOSHIBA CARRIER CORPORATION**  
336 TADEHARA, FUJI-SHI, SHIZUOKA-KEN 416-8521 JAPAN